



Productivity
redefined

DC Electric Fastening Systems



Toll-Free 1-866-763-6226 Phone: 905-672-5557

Fax: 905-672-5559 Email: sales@dobcoeqp.com



BECAUSE EVERY ASSEMBLY IS CRITICAL™

A Century of Innovation. A Legacy of Results.

For generations, Ingersoll-Rand has consistently delivered the most durable and reliable products in the industry. This legacy began with the creation of our first steam-powered rock drill more than 100 years ago, and has continued through countless innovations ever since.

Ingersoll-Rand
1905 - 2005



When you choose Ingersoll-Rand, you're getting more than precision, durability, and performance. You're partnering with a company that is as committed to your success as you are. Everyone on the Ingersoll-Rand team — from our engineers to factory technicians; from our sales team to your local distributors — is dedicated to supporting your investment and maximizing your productivity.

DOBCO
EQUIPMENT LTD

Toll-Free 1-866-763-6226 Phone: 905-672-5557
Fax: 905-672-5559 Email: sales@dobcoeqp.com

Taking Productivity Even Further.

DOBCO
EQUIPMENT LTD

Toll-Free 1-866-763-6226 Phone: 905-672-5557
Fax: 905-672-5559 Email: sales@dobcoeqp.com

You've got a critical job to do, and there are a lot of people counting on you to get it done right. At Ingersoll-Rand, we know what's at stake, too. That's why we deliver the most innovative and reliable fastening systems in the industry.

The foundation of your improved process is our newest technology — the IC1D and IC1M Series of closed-loop DC tool controllers. Matched with a new ICS software suite and our QE hand-held tools or new QM spindles, the IC controllers will deliver measurable improvements to your productivity, your process quality, and your bottom line.

It's productivity redefined, and it's only from Ingersoll-Rand.



Insight IC Controllers



Toll-Free 1-866-763-6226 Phone: 905-672-5557
Fax: 905-672-5559 Email: sales@dobcoeqp.com



IC1G / IC2G *Graphics*

IC1D *isplay*

IC1M *odule*

The IC1M, IC1D, and IC1G / IC2G controllers are powerfully precise, fully programmable, and can be seamlessly integrated with any QE or QM Series tools to deliver real performance advantages.

Productivity

Ask users of Ingersoll-Rand Insight controllers and they'll tell you our interface is best-in-class. The crisp, bright display on the IC1G / IC2G and IC1D provides instant feedback to the operator. Programming is quick and easy, and can either be done on-screen, from a computer with ICS Connect, or with the unique Parameter Transfer Key (PTK) (depending on the unit). You'll spend less time on set-up and more time assembling product.

Simplicity

All QE Series tools and QM Series spindles run on every single IC1D, IC1M, and IC1G / IC2G controller, without exception. This is a best-in-class feature that puts your productivity first.

Innovation

Ingersoll-Rand IC1D and IC1M controllers offer industry-leading functionality for their size. We pack extensive torque and angle control, as well as process management capabilities, into a small package saving you valuable real estate on the plant floor.

Configuration

Select exactly the system you need — no more, no less — by using our simple product selection guides. Simply specify your power supply, display type, input / output, communications, and accessories and we'll deliver your custom controller.

Reduced Cost of Ownership

Standard features like Ethernet and I/O connections on every unit mean no hidden charges for maximizing communication to your network. Also, there's no need for expensive hardware keys or back-up units. Common designs and components save you time and money in training and spare parts management.

Insight IC1G / IC2G Controllers



Toll-Free 1-866-763-6226 Phone: 905-672-5557
 Fax: 905-672-5559 Email: sales@dobcoeqp.com

Get maximum performance from your QE or QM tools with Ingersoll-Rand IC1G / IC2G controllers. The IC1G / IC2G controllers offer unmatched data storage, convenient menu navigation, and highly visible graphical displays.

Program and store up to 32 fastening configurations per spindle.

Best-in-class user interface lets you reach any screen in less than two key presses.

5,000-cycle end-of-run storage on the IC1G; 10,000 cycles on the IC2G (5,000 per spindle).

Bright OK / NOK lights provide clear feedback to the operator.

Capable of all basic and advanced multistep tightening strategies including yield, prevailing torque, and drag torque.

View, overlay, and manipulate up to five tightening curves.

Full-color VGA display shows final torque and angle in crisp detail.



CE certified.

Dual-mode power supply: 90 – 120 VAC and 200 – 240 VAC.

Ethernet, serial, parallel, bar code, Profibus, and DeviceNet connections are available.



Up to 24 inputs and outputs.

IC1G / IC2G SELECTION GUIDE

IC 2 G 1 C 1 C F

POWER SUPPLY

- 1 110 VAC U.S. standard with pigtail
- 2 220 VAC U.S. standard with pigtail
- 3 230 VAC EU cable

DISPLAY

- G Full-color VGA graphics

SPINDLES

- 1 One spindle
- 2 Two spindles

CONTROLLER SERIES

NETWORK COMMUNICATIONS

- 1 Standard system — serial, parallel, Ethernet
- 3 Profibus plus standard system
- 4 DeviceNet plus standard system

I/O TERMINALS

- A Standard eight inputs and outputs per spindle
- B One additional card of 16 inputs and outputs (IC1G only)
- C Two additional cards of 16 inputs and outputs (IC2G only)

DRIVE

- F 3-1/2" floppy drive
- N No drive

PCMCIA CARD

- A No card
- C Flash memory

Insight IC1D Controllers



Toll-Free 1-866-763-6226 Phone: 905-672-5557
 Fax: 905-672-5559 Email: sales@dobcoeqp.com

The new Ingersoll-Rand Insight IC1D controllers give you full closed-loop control in an industry-leading compact size. With features like a VGA color display and intuitive programming interface, the IC1D units provide unmatched performance and value.

Professional 1/4 VGA 216-color display is visible from 20 ft (6.1 m).

Program up to eight basic fastening configurations and access all 256 stored in memory.

Removable cover provides easy access to connections and terminals, even when the unit is installed.

Parameter Transfer Key (PTK) enables quick upload, recovery, transfer, and storage of configuration sets.

Power switch is enclosed in rubber boot for protection.

Standard Ethernet and I/O connections optimize communication and line integration.

The controller has 1,000 cycles of end-of-run automatic data storage.

Dual-mode power supply: 90 – 120 VAC and 200 – 240 VAC.

Internal maximum ambient operating temperatures of 0° – 50° C (32° – 122° F) ensure reliable use in demanding conditions without risk of overheating.

Easy installation and set-up with convenient bracketing system.

Comfortable and tactile membrane facilitates easy programming and screen navigation.

Extruded aluminum cooling fins.



Expand the capabilities of the IC1D with ICS Software. See page 7.

IC1D SELECTION GUIDE

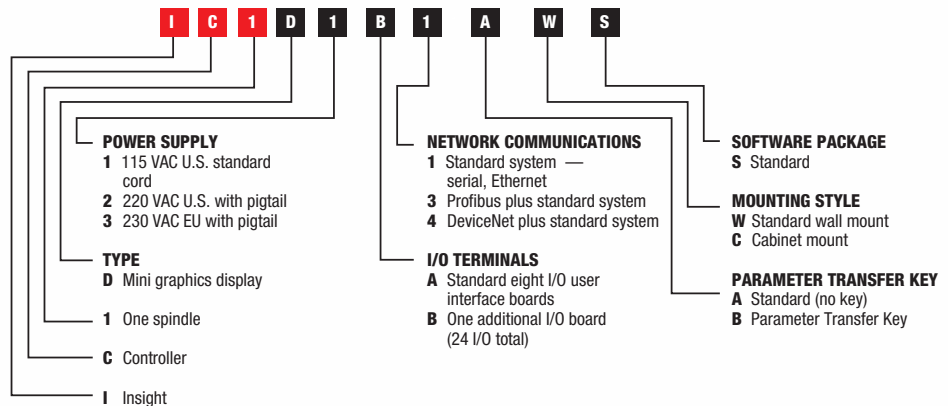

Insight IC1M Controllers



Toll-Free 1-866-763-6226 Phone: 905-672-5557
 Fax: 905-672-5559 Email: sales@dobcoeqp.com

The Ingersoll-Rand IC1M controller is a basic single-spindle controller. The IC1M works seamlessly with all QE Series tools and QM Series spindles, and can be mounted in a rack or cabinet as a single unit or in groups of up to 40 to drive multispindle systems.

Parameter Transfer Key (PTK) enables quick upload, recovery, transfer, and storage of configuration sets.

Dual-mode power supply: 90 – 120 VAC and 200 – 240 VAC.

One-line digital display shows torque or angle.

200 cycles of end-of-run automatic data storage.

Use ICS Connect to program and select from 256 basic configurations stored in memory.

Standard Ethernet and I/O connections optimize communication and line integration.

Removable cover provides easy access to connections and terminals, even when the unit is installed.

Internal maximum ambient operating temperatures of 0° – 60° C (32° – 140° F) ensure reliable use in demanding conditions without risk of overheating.

Front-mounted cable allows top-to-bottom stacking of units for multispindle applications.

Easy installation and set-up with a convenient bracketing system.

Extruded aluminum cooling fins.

Power switch is enclosed in rubber boot for protection.



IC1M SELECTION GUIDE

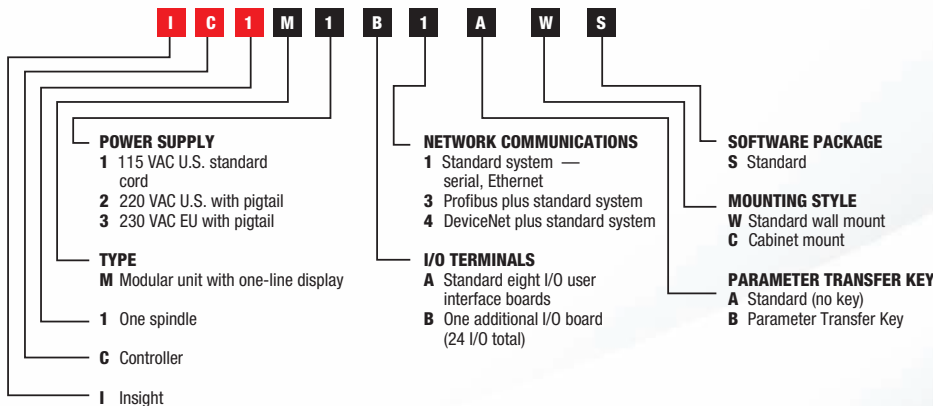

Expand the capabilities of the IC1M with ICS Software. See page 7.

ICS Software Suite



Toll-Free 1-866-763-6226 Phone: 905-672-5557
Fax: 905-672-5559 Email: sales@dobcoeqp.com

Paired with an Insight IC1D or IC1M controller and a computer, our groundbreaking ICS Software Suite makes it possible to more precisely control and monitor your fastening process. Optimizing your system is as simple as selecting one of four packages.



ICS Connect

ICS Connect provides operators the ability to access and program basic fastening strategies, as well as view cycle data with a single IC1D or IC1M controller via a one-to-one Ethernet connection. ICS Connect is supplied standard with all IC1D and IC1M controllers.

ICS Network

ICS Network enables programming of multiple IC1D and IC1M controllers connected through a local area network (LAN) or direct connection. This option also allows operators to program advanced fastening strategies including yield and prevailing torque control.

ICS MultiSync

The ICS MultiSync package facilitates set-up and control of multispindle systems consisting of up to 100 spindles in groups of up to 40 spindles. This package also offers advanced multispindle fastening strategies, remote monitoring, and data archiving.

ICS Enterprise

ICS Enterprise offers advanced programming and management of a network of up to 500 IC1D or IC1M controllers using QE tools, QM spindles, or multispindle systems. Also enables ODBC-compliant database archiving, searching, and statistics processing.

ICS Connect

Features

- Enables access to and basic programming of all 256 configurations on IC1D and IC1M controllers
- Provides the primary means of programming an IC1M controller
- Provides quick functionality set-up for single-step torque and angle strategies on the IC1D and IC1M controllers
- Captures cycle log, event log, and statistical data
- Enables runtime viewing of fastening data with live screen updating

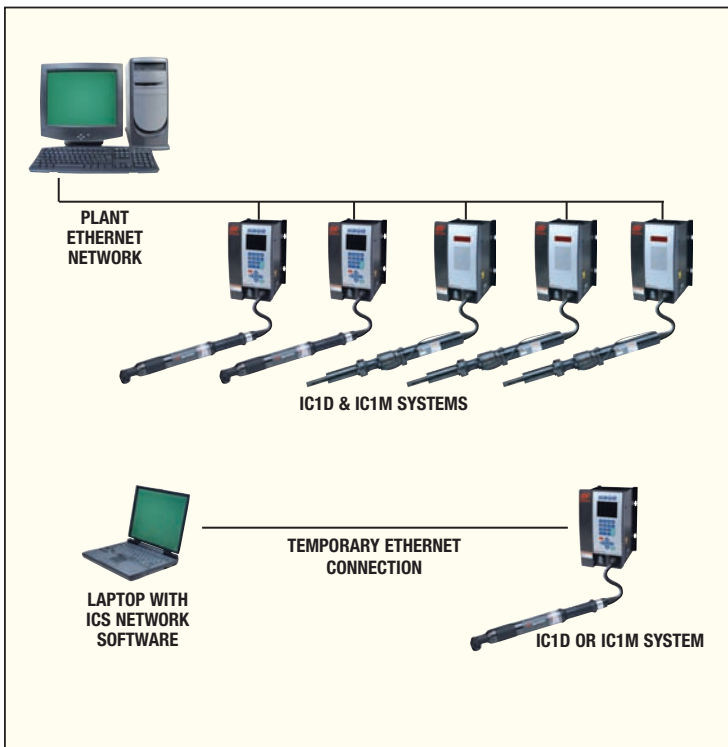
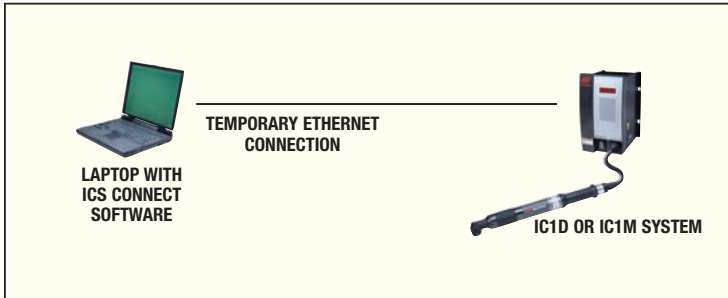

ICS Network

Features

- Allows operators to connect, manage, view, and program up to 500 IC1D or IC1M controllers (depending on license) through a local area network
- Enables programming of advanced multistep tightening strategies including drag torque and prevailing torque on IC1D and IC1M controllers
- Activates the innovative TactAlert capability of QE Series tools
- Generates detailed statistical charts and graphs
- Enables viewing of a single tightening curve
- Programs preventive maintenance (PM) alarms
- Enables "Stats Alarms" function
- Provides bar code and field bus interfaces

ICS MultiSync

Features

- Programs all regular and powerhead tightening strategies within IC1D and IC1M controllers
- Enables programming and synchronization of up to 100 connected QE Series tools or QM Series spindles
- Enables advanced multispindle strategies such as back-out, fault back-out, final fault back-out, and torque recovery
- Programs and synchronizes spindles to function without software intervention
- Archives tightening data to an internal data table when running in stand-alone powerhead mode
- Collects and supplies data as required when used with ICS Enterprise
- Archives data for all spindles connected

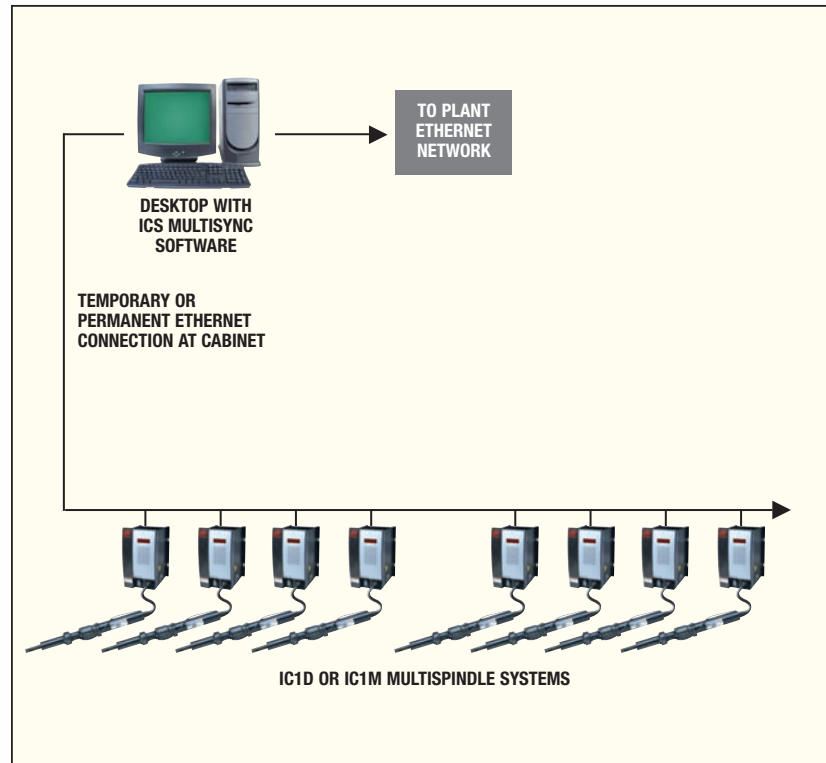

ICS Enterprise

Features

- Provides all of the functionality of ICS Connect, ICS Network, and ICS MultiSync
- Offers advanced programming and network management of up to 500 IC1D or IC1M controllers with QE Series tools, QM Series spindles, or multispindle systems (depending on license)
- Enables output of data to ODBC-compliant database to archive cycle data, curves, parameter settings, diagnostics, event logs, and statistics
- Schedules regular archiving based on time or number of cycles
- Enables data sorting, searching, and reporting by shift, tool ID, VIN, and more
- Provides 10-curve, on-screen tightening curve overlay to mimic IC1G / IC2G display capabilities

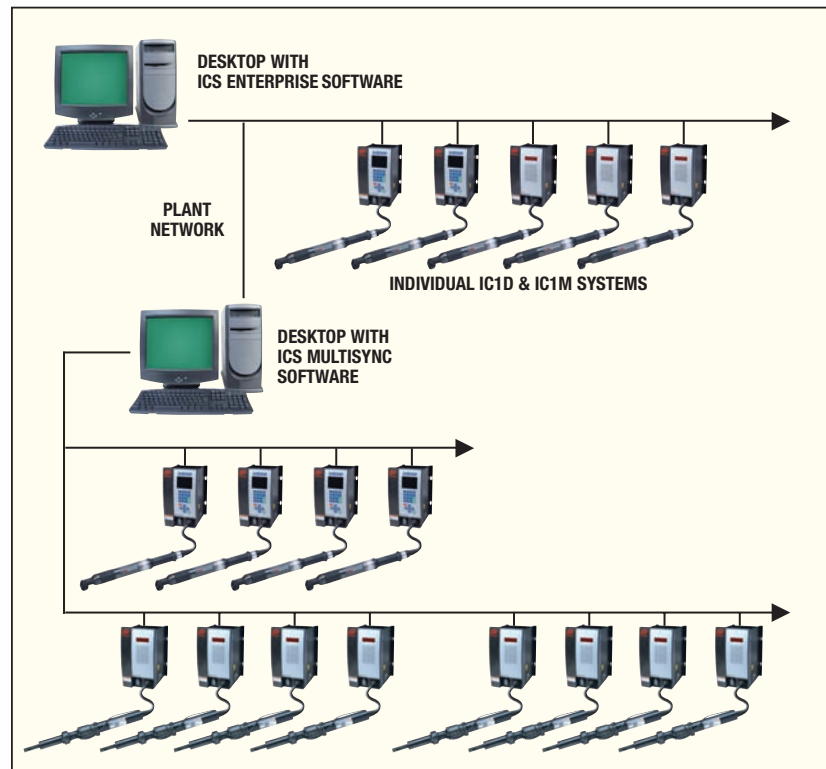

The Ingersoll-Rand QE Series hand-held and fixtured tools take productivity, ergonomics, and reliability to new levels. With angle, in-line, pistol, push-to-start, and offset configurations, three motor platforms, and torque coverage to 400 Nm, our QE Series tools are engineered for enhanced productivity with impressive features.

When matched with an IC1G, IC2G, IC1D, or IC1M controller, the ICS Software Suite, and any of our productivity-enhancing accessories, our QE Series tools redefine your productivity.

Productivity

- Faster speeds at torque than competitive tools
- Automatic tool identification means any Insight controller can instantly recognize any QE tool — without manual entry of tool torque range, motor characteristics, or transducer values
- Improved accuracy with Sine Drive technology
- Programmable momentary switch
- Optimum flexibility through modular designs
- Patented TactAlert provides the operator with tactile feedback of a tool fault or NOK signal through gentle mechanical oscillation in the grip surface, reducing reliance on visual or audible signals

Ergonomics

- Compact, lightweight designs
- Comfortable grip surfaces and smooth contours
- Low-force triggers and rotary reverse switches

Reliability

- Digital link between tool and controller
- Durable chassis
- Non-contacting switches
- Two-year standard warranty on all tool cables



QE Series Tools



Toll-Free 1-866-763-6226 Phone: 905-672-5557
 Fax: 905-672-5559 Email: sales@dobcoeqp.com



QE4 System

QE4 SELECTION GUIDE

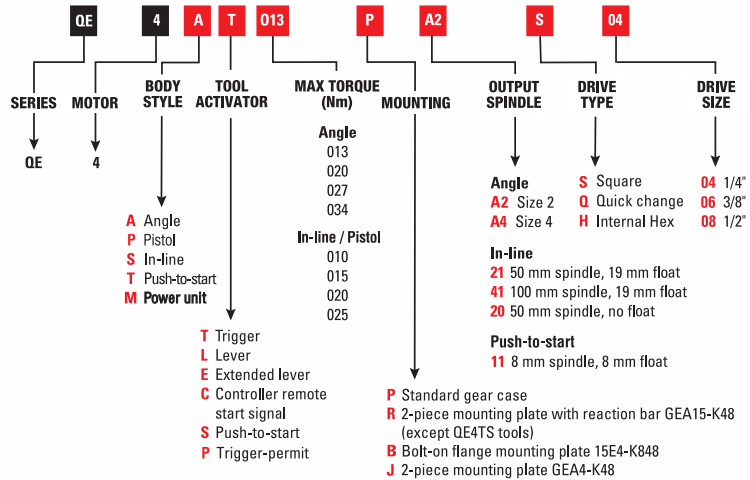

QE6 System

QE6 SELECTION GUIDE

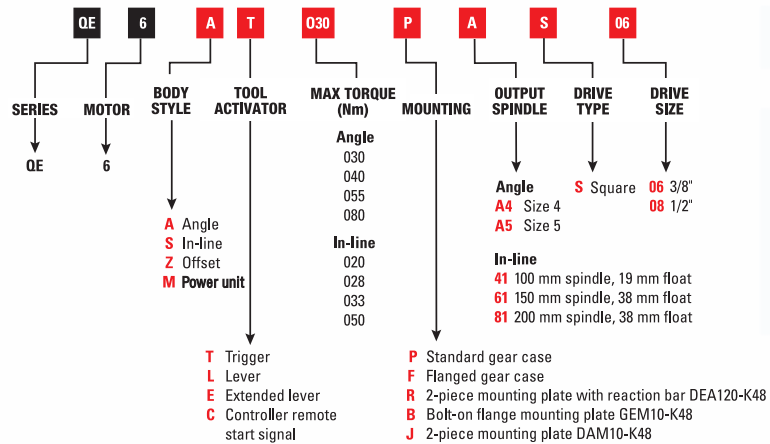

QE8 System

QE8 SELECTION GUIDE

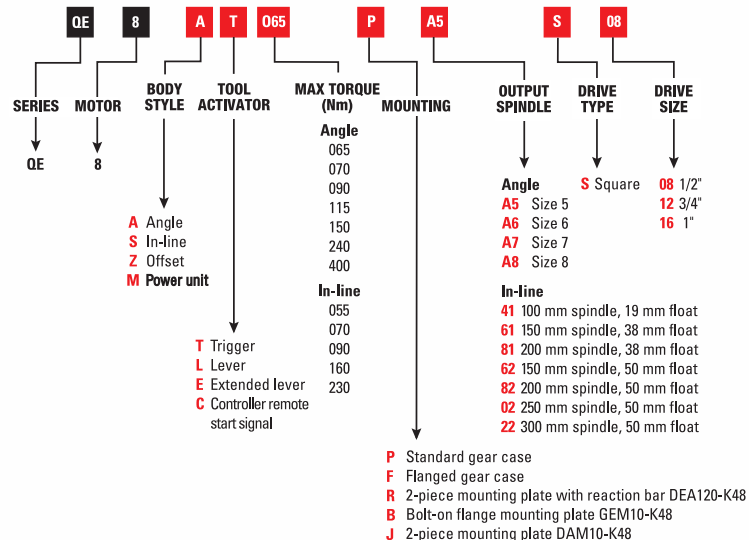

QE Hand-held DC Electric Tools • Specifications



MODEL	MAX. TORQUE Nm	REC. TORQUE RANGE Nm	SPEED rpm	WEIGHT kg	LENGTH mm	TORQUE (Nm)																			
						20	40	60	80	100	120	140	160	180	200	220	240	260	280	300	320	340	360	380	
ANGLE TOOLS																									
QE4A() 013()	13	3-10	1,200	1.3	370	[Bar chart showing torque range]																			
QE4A() 020()	20	4-16	820	1.3	370	[Bar chart showing torque range]																			
QE4A() 027()	27	5-22	600	1.3	370	[Bar chart showing torque range]																			
QE4A() 034()	34	7-27	470	1.3	370	[Bar chart showing torque range]																			
QE6A() 030()	30	6-24	1,230	1.9	440	[Bar chart showing torque range]																			
QE6A() 040()	40	8-32	910	1.9	440	[Bar chart showing torque range]																			
QE6A() 055()	55	11-44	650	1.9	440	[Bar chart showing torque range]																			
QE6A() 080()	80	16-64	440	1.9	440	[Bar chart showing torque range]																			
QE8A() 065()	65	13-52	1,200	2.9	515	[Bar chart showing torque range]																			
QE8A() 070()	70	14-56	1,100	2.9	515	[Bar chart showing torque range]																			
QE8A() 090()	90	18-72	850	2.9	515	[Bar chart showing torque range]																			
QE8A() 115()	115	23-92	660	2.9	515	[Bar chart showing torque range]																			
QE8A() 150()	150	30-120	510	2.9	515	[Bar chart showing torque range]																			
QE8A() 225()	225	45-180	310	4.1	575	[Bar chart showing torque range]																			
QE8A() 400()	400	80-320	170	6.0	635	[Bar chart showing torque range]																			
IN-LINE TOOLS																									
QE4S() 010()	10	2-8	1,820	1.2	390	[Bar chart showing torque range]																			
QE4S() 015()	15	3-11	1,220	1.2	390	[Bar chart showing torque range]																			
QE4S() 020()	20	4-16	900	1.2	390	[Bar chart showing torque range]																			
QE4S() 025()	25	5-20	710	1.2	390	[Bar chart showing torque range]																			
QE6S() 020()	20	4-16	1,840	2.1	500	[Bar chart showing torque range]																			
QE6S() 028()	28	6-22	1,360	2.1	500	[Bar chart showing torque range]																			
QE6S() 033()	33	7-26	1,130	2.1	500	[Bar chart showing torque range]																			
QE6S() 050()	50	10-40	760	2.1	500	[Bar chart showing torque range]																			
QE8S() 055()	55	11-44	1,470	3.0	557	[Bar chart showing torque range]																			
QE8S() 070()	70	14-56	1,160	3.0	557	[Bar chart showing torque range]																			
QE8S() 090()	90	18-72	900	3.0	557	[Bar chart showing torque range]																			
QE8S() 150()	150	30-120	500	3.4	572	[Bar chart showing torque range]																			
QE8S() 230()	230	45-184	340	5.5	710	[Bar chart showing torque range]																			
PUSH-TO-START TOOLS																									
QE4TS() 010()	10	2-8	1,820	1.2	340	[Bar chart showing torque range]																			
QE4TS() 015()	15	3-12	1,220	1.2	340	[Bar chart showing torque range]																			
QE4TS() 020()	20	4-16	900	1.2	340	[Bar chart showing torque range]																			
QE4TS() 025()	25	5-20	710	1.2	340	[Bar chart showing torque range]																			
PISTOL TOOLS																									
QE4P() 010()	10	2-8	1,820	1.3	234	[Bar chart showing torque range]																			
QE4P() 015()	15	3-12	1,220	1.3	234	[Bar chart showing torque range]																			
QE4P() 020()	20	4-16	900	1.3	234	[Bar chart showing torque range]																			
QE4P() 025()	25	5-20	710	1.3	234	[Bar chart showing torque range]																			

LEGEND

RECOMMENDED RANGE (BLUE) → [Dark Blue Bar] ←

→ [Light Blue Bar] ← MAX TORQUE (LIGHT BLUE)



QE Fixtured DC Electric Tools • Specifications



	MODEL	MAX. TORQUE Nm	REC. TORQUE RANGE Nm	SPEED rpm	WEIGHT kg	LENGTH mm	TORQUE (Nm)																																	
							20	40	60	80	100	120	140	160	180	200	220	240	260	280	300	320	340	360	380															
ANGLE TOOLS	QE4AC() 013()	13	3-10	1,200	1.3	370	█																																	
	QE4AC() 020()	20	4-16	820	1.3	370	█	█																																
	QE4AC() 027()	27	5-22	600	1.3	370	█	█	█																															
	QE4AC() 034()	34	7-27	470	1.3	370	█	█	█	█																														
	QE6AC() 030()	30	6-24	1,230	1.9	440	█	█	█																															
	QE6AC() 040()	40	8-32	910	1.9	440	█	█	█	█																														
	QE6AC() 055()	55	11-44	650	1.9	440	█	█	█	█	█																													
	QE6AC() 080()	80	16-64	440	1.9	440	█	█	█	█	█	█																												
	QE8AC() 065()	65	13-52	1,200	2.9	515	█	█	█	█	█	█																												
	QE8AC() 070()	70	14-56	1,100	2.9	515	█	█	█	█	█	█																												
	QE8AC() 090()	90	18-72	850	2.9	515	█	█	█	█	█	█																												
	QE8AC() 115()	115	23-92	660	2.9	515	█	█	█	█	█	█																												
	QE8AC() 150()	150	30-120	510	2.9	515	█	█	█	█	█	█	█																											
QE8AC() 225()	225	45-180	310	4.1	575								█	█	█	█	█	█	█	█	█	█																		
QE8AC() 400()	400	80-320	170	6.0	635																																			
IN-LINE TOOLS	QE4SC() 010()	10	2-8	1,820	1.2	390	█																																	
	QE4SC() 015()	15	3-11	1,220	1.2	390	█	█																																
	QE4SC() 020()	20	4-16	900	1.2	390	█	█	█																															
	QE4SC() 025()	25	5-20	710	1.2	390	█	█	█	█																														
	QE6SC() 020()	20	4-16	1,840	2.1	500	█	█																																
	QE6SC() 028()	28	6-22	1,360	2.1	500	█	█	█																															
	QE6SC() 033()	33	7-26	1,130	2.1	500	█	█	█																															
	QE6SC() 050()	50	10-40	760	2.1	500	█	█	█	█																														
	QE8SC() 055()	55	11-44	1,470	3.0	557	█	█	█	█	█																													
	QE8SC() 070()	70	14-56	1,160	3.0	557	█	█	█	█	█	█																												
	QE8SC() 090()	90	18-72	900	3.0	557	█	█	█	█	█	█																												
QE8SC() 150()	150	30-120	500	3.4	572	█	█	█	█	█	█																													
QE8SC() 230()	230	45-184	340	5.5	710	█	█	█	█	█	█																													
OFFSET TOOLS	QE6ZC() 020()	20	4-16	1,840	2.5	600	█	█																																
	QE6ZC() 028()	28	6-22	1,360	2.5	600	█	█	█																															
	QE6ZC() 033()	33	7-26	1,130	2.5	600	█	█	█																															
	QE6ZC() 050()	50	10-40	760	2.5	600	█	█	█	█																														
	QE8ZC() 055()	55	11-44	1,470	3.0	710	█	█	█	█	█																													
	QE8ZC() 070()	70	14-56	1,160	3.0	710	█	█	█	█	█	█																												
	QE8ZC() 090()	90	18-72	900	4.0	710	█	█	█	█	█	█																												
	QE8ZC() 150()	150	30-120	500	4.0	770	█	█	█	█	█	█																												
QE8ZC() 230()	230	45-184	340	4.0	770	█	█	█	█	█	█																													

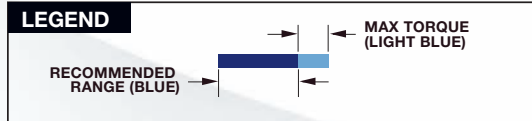

QE Pistol Nutrunners

Features

- Torque coverage to 25 Nm (9 – 220 in-lb)
- Impressive maximum tool speeds of 1,820 rpm
- Ergonomic housing design based on award-winning Q2 platform
- Three trigger options: push-to-start, trigger-start, and trigger-permit, an industry first
- White LED headlight for work illumination
- Green-yellow-red OK / NOK indicator lights on back cap
- Dead handle

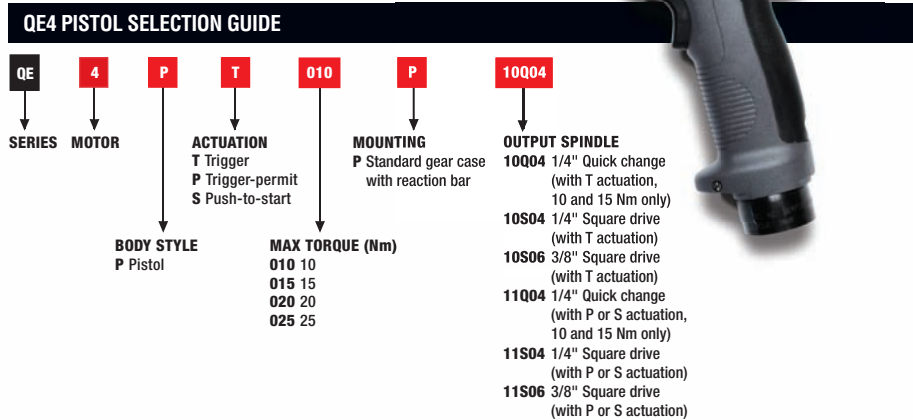

Other QE Options

Every fastening operation has unique requirements, and Ingersoll-Rand can provide a configured solution designed to meet your needs. We offer tube nut, crows foot, and other geared offset heads in a variety of sizes that can be perfectly matched with a QE4, QE6, or QE8 tool that's right for your application. Contact your local representative today and let Ingersoll-Rand design and deliver your ideal tool.



QM Series Spindles



Toll-Free 1-866-763-6226 Phone: 905-672-5557
Fax: 905-672-5559 Email: sales@dobcoeqp.com



QM Series DC spindles are the workhorse of your multispindle application. With four platforms that provide broad torque and speed coverage, Ingersoll-Rand QM spindles deliver the highest level of performance, durability, and reliability in the industry. The QM3, QM5, QM7, and QM9 platforms are so durable, in fact, that we stopped testing them after three million fault-free cycles.

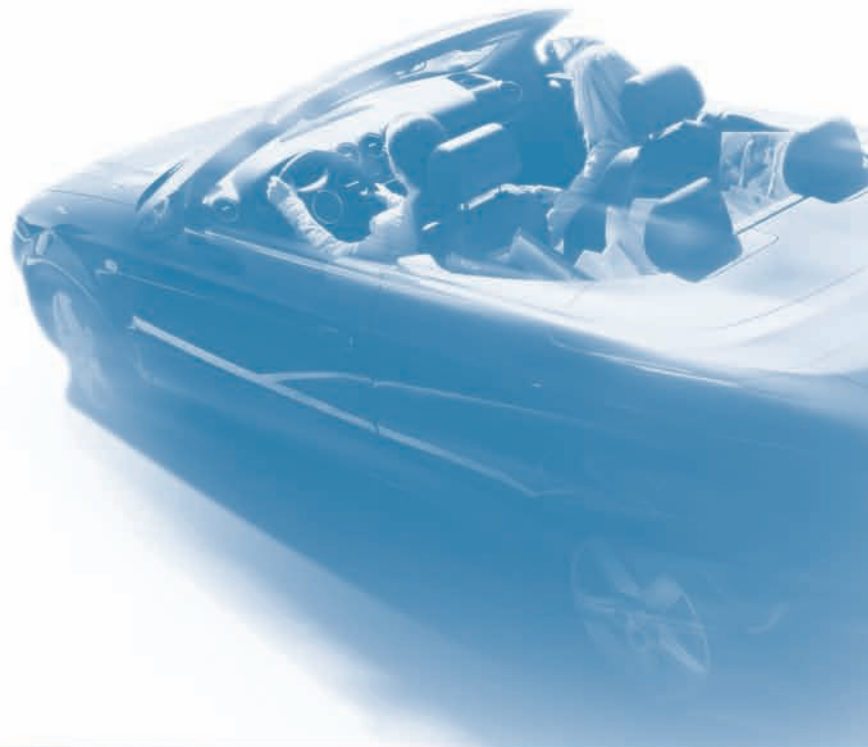

With our QM Series spindles on your assembly line, you'll be able to redefine the productivity of your process through these outstanding features:

- Torque coverage from 3 to 1000 Nm*
- Better than five percent capability with all four motor platforms
- Highly durable with limited standard preventive maintenance required
- All QM spindles run seamlessly on any IC1G / IC2G, IC1D, or IC1M controller
- Flexible mounting options include front-mounting or sandwich-mounting for any unit
- External electronics pod simplifies mounting and connectivity (QM spindles use the same tool cables as the QE Series hand-held tools)
- Highly configurable platform allows users to select output torque, body style, sensor type, and spindle type to create the perfect tool for the application
- An onboard PTC monitors the motor temperature and protects the unit from excessive heat
- Easy to service — no special tools needed
- CE certified

**Higher torque QM spindles are available. Contact your local Ingersoll-Rand representative for details.*



QM3 System



QM5 System



QM7 System



QM9 System

QM Series Spindles



Toll-Free 1-866-763-6226 Phone: 905-672-5557
 Fax: 905-672-5559 Email: sales@dobcoeqp.com

MODEL	MAX. TORQUE Nm	REC. TORQUE RANGE Nm	SPEED rpm	DRIVE in	TORQUE (Nm)																			
					50	100	150	200	250	300	350	400	450	500	550	600	650	700	750	800	850	900	950	1000
QM3S() 008()	8	2-6	1,382	3/8" or 1/2"																				
QM3S() 012()	12	3-10	927	3/8" or 1/2"																				
QM3S() 016()	16	4-13	686	3/8" or 1/2"																				
QM3S() 020()	20	4-16	545	3/8" or 1/2"																				
QM5S() 035()	35	7-28	590	3/8" or 1/2"																				
QM5S() 055()	55	11-44	507	3/8" or 1/2"																				
QM5S() 090()	90	18-72	280	1/2"																				
QM7S() 190()	190	38-152	273	3/4" or 1/2"																				
QM7S() 220()	220	44-176	233	3/4"																				
QM9S() 315()	315	63-250	278	3/4" or 1"																				
QM9S() 435()	435	87-348	203	3/4" or 1"																				
QM9S() 520()	520	104-416	170	3/4" or 1"																				
QM9S() 650()	650	130-520	136	1"																				
QM9S() 01K()	1000	200-800	51	1"																				

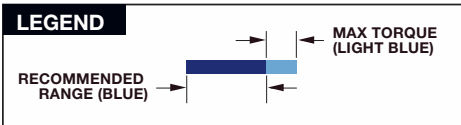

QM3 SELECTION GUIDE

Q SERIES
M FAMILY
3 MOTOR
S BODY STYLE
S SENSOR
008 MAX TORQUE (Nm)
L SPRING TENSION
62S06 SPINDLES

SENSOR
 S Single transducer
 N Transducer blank
 B Power unit

SPRING TENSION
 L Light
 H Heavy
 S Solid spindle

BODY STYLE
 S Straight
 M Power unit

MAX TORQUE (Nm)
 008
 012
 016
 020

SPINDLES
62S06 6" long, 50 mm float, 3/8" square
92S06 9" long, 50 mm float, 3/8" square
22S06 12" long, 50 mm float, 3/8" square
62S08 6" long, 50 mm float, 1/2" square
92S08 9" long, 50 mm float, 1/2" square
22S08 12" long, 50 mm float, 1/2" square



QM5 SELECTION GUIDE

Q SERIES
M FAMILY
5 MOTOR
S BODY STYLE
S SENSOR
035 MAX TORQUE (Nm)
L SPRING TENSION
62S06 SPINDLES

SENSOR
 S Single transducer
 N Transducer blank
 B Power unit

SPRING TENSION
 L Light
 H Heavy
 S Solid spindle

BODY STYLE
 S Straight
 M Power unit

MAX TORQUE (Nm)
 035
 055
 090

SPINDLES
62S06 6" long, 50 mm float, 3/8" square
92S06 9" long, 50 mm float, 3/8" square
22S06 12" long, 50 mm float, 3/8" square
62S08 6" long, 50 mm float, 1/2" square
92S08 9" long, 50 mm float, 1/2" square
22S08 12" long, 50 mm float, 1/2" square



MODEL	C-C DISTANCE (mm)	WEIGHT lb (kg)	SPINDLE RETRACTION (mm)	A (mm)	B (mm)	C (mm)	D (mm)
QM3	34	5.21 (2.36)	50	446.4	168.6	178.6	10
QM5	44	8.59 (3.9)	50	565	168.6	178.6	11.2
QM7	70	18.61 (8.44)	50	643.1	193.6	202.9	11.2
QM9	89	41.03 (18.6)	50	731	221.3	234	18

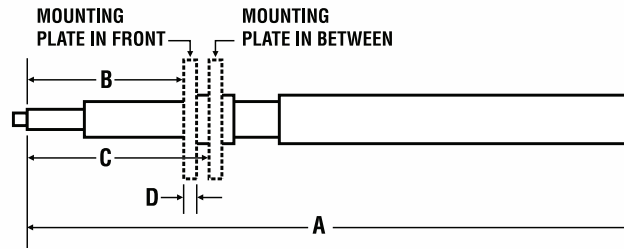

QM7 SELECTION GUIDE

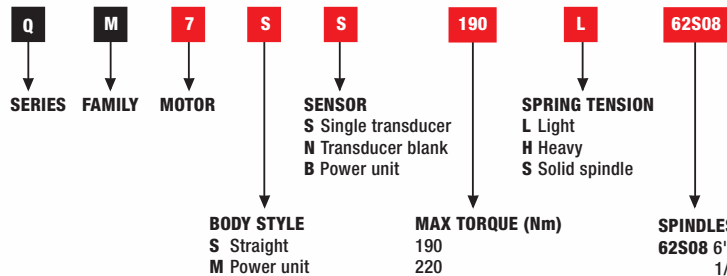

- SPINDLES**
- 62S08** 6" long, 50 mm float, 1/2" square
 - 92S08** 9" long, 50 mm float, 1/2" square
 - 22S08** 12" long, 50 mm float, 1/2" square
 - 62S12** 6" long, 50 mm float, 3/4" square
 - 92S12** 9" long, 50 mm float, 3/4" square
 - 22S12** 12" long, 50 mm float, 3/4" square

QM9 SELECTION GUIDE

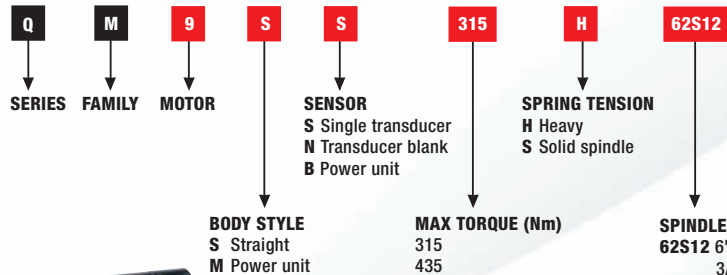

- SPINDLES**
- 62S12** 6" long, 50 mm float, 3/4" square
 - 92S12** 9" long, 50 mm float, 3/4" square
 - 22S12** 12" long, 50 mm float, 3/4" square
 - 62S16** 6" long, 50 mm float, 1" square
 - 92S16** 9" long, 50 mm float, 1" square
 - 22S16** 12" long, 50 mm float, 1" square

Custom Fastening Systems



Toll-Free 1-866-763-6226 Phone: 905-672-5557
Fax: 905-672-5559 Email: sales@dobcoeqp.com

Ingersoll-Rand provides more than just the building blocks for your fastening applications. We offer the global depth of engineering expertise to design and build turn-key, multispindle assembly solutions for nearly any industrial application. Whether for motor vehicle wheel installation, engine assembly, or component assembly, Ingersoll-Rand has designed and

installed fixtured multispindle systems around the world. Contact your local Ingersoll-Rand representative or your local distributor for a quotation on your next multispindle system. Let Ingersoll-Rand show you how to transform QM spindles, ICS Software, and IC1D and IC1M controllers into a configured solution that helps redefine your productivity.



Complete your total assembly solution with a wide assortment of Ingersoll-Rand fastening system accessories. Whether you need tool holders, torque arms, spare cables, light towers, or socket trays, our parts and accessories are guaranteed to provide the durability and reliability you expect from Ingersoll-Rand.



Tool Cables



90° Tool Cables



Extended Lever Kit



Swivel Hanger Kit



Flanged Mounting Kits



Mounting Plate Kits

DESCRIPTION		PART NUMBER
CABLES		
Tool Cables	3 m	GEA40-CORD-3M
	NEW! 6 m	GEA40-CORD-6M
	10 m	GEA40-CORD-10M
90° Tool Cables	3 m	GEA40-CORD-3M-90
	NEW! 6 m	GEA40-CORD-6M-90
	10 m	GEA40-CORD-10M-90
Extension Cables	10 m	GEA40-EXT-10M
	20 m	GEA40-EXT-20M
	40 m	GEA40-EXT-40M
LEVER KITS		
Short Lever Kit	QE Series	GEA40-K98SL
Extended Lever Kit	QE Series	GEA40-K98EL (shown)
SWIVEL HANGER KIT	QE6 & QE8 Series	GEA40-K364
SUSPENSION BAIL	QE Series	7L-365
REACTION BAR KITS (for retrofitting add DAA4-27)		
	QE4 Series	GEA15-K48
	QE4TS Series	GEPTS15-K48
	QE6 & QE8 Series	DEA120-K48
FLANGED MOUNTING KITS (for retrofitting add DAA4-27)		
	QE4 Series	15E4-K48
	QE6 & QE8 Series	GEM120-K48
MOUNTING PLATE KITS (for retrofitting add DAA4-27)		
	QE4 Series	GEA4-K48
	QE6 & QE8 Series	DAM120-K48

Accessories



Toll-Free 1-866-763-6226 Phone: 905-672-5557
 Fax: 905-672-5559 Email: sales@dobcoeqp.com



Socket Tray



Palm Button Reset Station



Emergency Stop Button



Light Tower



5-port Switch

DESCRIPTION		PART NUMBER
SOCKET TRAYS	4-position Socket Tray	IC-SOCKET-4 (shown)
	8-position Socket Tray	IC-SOCKET-8
SELECTOR SWITCHES	4-position Remote Selector Switch	IC-SELECT-4
	8-position Remote Selector Switch	IC-SELECT-8
PALM BUTTON RESET STATION		IC-PALM-RESET (shown)
EMERGENCY STOP BUTTON		IC-ESTOP (shown)
LIGHT TOWER		LCE-FB (shown)
COMMUNICATION HUBS	Industrial-duty 5-port Switch	IC-SW-5 (shown)
	Industrial-duty 16-port Switch	IC-SW-16
	IP67 Sealed 5-port Switch	IC-SWS-5
	IP67 Sealed 16-port Switch	IC-SWS-16
WALL MOUNTING BRACKET		3002007
CABINET MOUNTING BRACKET		3002010
PARAMETER TRANSFER KEY		8015013 (shown)



Parameter Transfer Key



Parameter Transfer Key





Toll-Free 1-866-763-6226 Phone: 905-672-5557
 Fax: 905-672-5559 Email: sales@dobcoeqp.com

Torque Arms

PARALLEL TORQUE ARM

Model	IRBP3-E30
Length	30 in (762 mm)
Range	0 – 10 Nm
Torque Absorber	Yes

EZ TOOL ARM*

Part Number	Description
EZTA080500	Torque arm with tool holder
43146000	Torque arm without tool holder
GEPTS15-K48	QE4TS Tool Adapter

*Torque range 0 – 30 Nm.

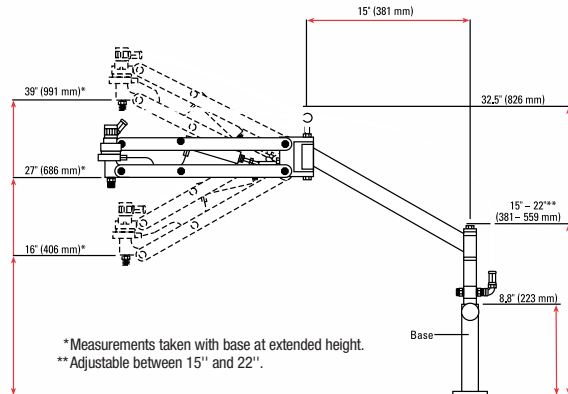

Torque Tubes

- Available in three torque capacities — 100 Nm, 250 Nm, and 500 Nm
- Linear bearings for effortless vertical travel and maintenance-free operation
- Lifting capacities of 60 and 400 lb
- Four Delrin wheels for torque reaction and side loading in all directions
- Adjustable lengths every 2 inches to eliminate the need for extension tubes
- Available bolt-on attachments for tool holders and suspension

Part Number 54044227 Part Number 54041819 Part Number 54044417

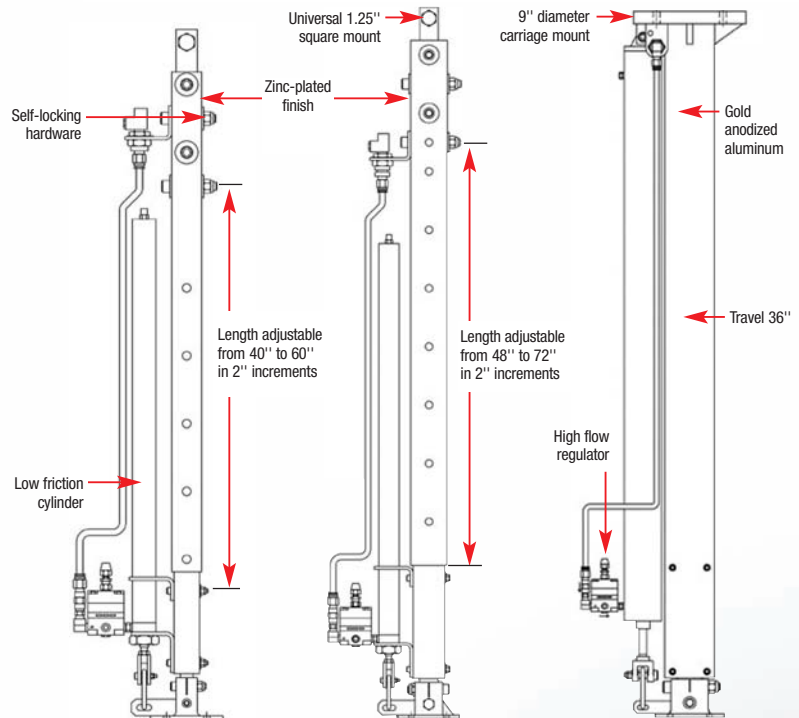

Part Number 52000

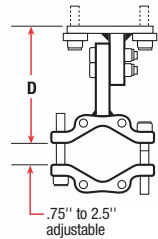

Fixed (2 axis)
horizontal or vertical tool holder

Part Number 52100

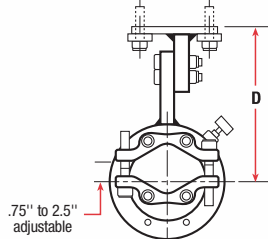

360° (3 axis)
swivel tool holder

TORQUE TUBES

Part Number	Description	Torque Capacity ft-lb (Nm)	Lift Capacity @ 100 psi lb (kg)	Weight lb (kg)	Travel in (mm)
54044227	IRZ-TT-100	74 (100)	60 (27)	40 (18)	20 (508)
54041819	IRZ-TT-250	184 (250)	60 (27)	50 (23)	24 (610)
54044417*	IRZ-TT-500	368 (500)	400 (182)	75 (75)	36 (914)

*Carriage mount option only; custom tool holder required. Contact factory for details.

TOOL HOLDERS

Part Number	For Use With	Description	"D" Dimension in (mm)	Weight lb (kg)
52000	54044227	Fixed (2 axis) horizontal/vertical	4.82 (122)	2.30 (.90)
52100	54041819	360° (3 axis) swivel	5.38 (136.7)	5.00 (2.27)

Expert Torque Analysis Systems



Toll-Free 1-866-763-6226 Phone: 905-672-5557
 Fax: 905-672-5559 Email: sales@dobcoeqp.com

ETA Series Expert Torque Analyzer

The Ingersoll-Rand Expert Torque Analyzer is designed for use with a broad range of transducers to dynamically measure and record the torque output of all types of fastening tools, including pulse tools. The Expert Torque Analyzer has full statistical capability, and all data can be downloaded to a computer or printer via the RS232 port. The full line of joint kits facilitates testing of fastening tools in the tool crib, quality lab, or on the line.

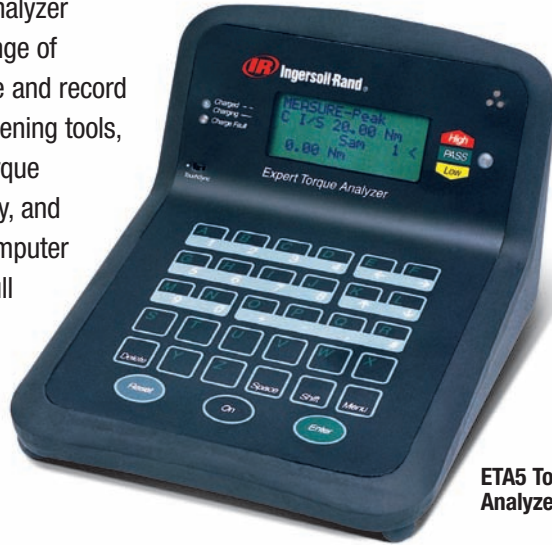

ETA5 Torque Analyzer

Features

- Full touch membrane keypad
- Four-line LED display
- Torque status lights
- High strength aluminum case
- Protective rubber trim
- Neck strap connector
- Contoured bottom
- Battery charger status

ETA Transducers

Ingersoll-Rand rotary and stationary transducers span the range of 1.5 – 1000 Nm. These transducers will work with pulse tools, nutrunners, screwdrivers, click wrenches, hand torque wrenches, and direct drive tools and motors in either a clockwise or counterclockwise direction. Their patented “wrap-around” brush system reduces the chance of noise in the signal and eliminates the possibility of contact loss.

Standard industry transducers will work with the ETA Series and other equipment that utilizes standard transducers. The ETA “Smart” Series transducers are specifically designed to work with the ETA analyzers. The ETA2 and ETA5 analyzers will automatically identify the transducer’s range and calibration through data stored on their “Smart” chip. The ETA Series transducers are available to measure torque and angle of rotation.

Rotary Transducers

Drive Size	Transducer Range		Industry Standard*	ETA Series “Smart” Transducers	
	Nm	(in-lb) ft-lb		Torque	Torque & Angle
1/4" Hex	.10 – 2	(1.0 – 18)	TR2H4	—	—
1/4" Hex	.25 – 5	(2.2 – 44)	TR5H4	TRD5H4	TRDA5H4
1/4" Hex	1 – 20	(9.0 – 180)	TR20H4	TRD20H4	TRDA20H4
1/4" Square	1 – 20	(9.0 – 180)	TR20S4	TRD20S4	TRDA20S4
3/8" Square	3.8 – 75	2.8 – 55	TR75S6	TRD75S6	TRDA75S6
1/2" Square	9 – 180	6.7 – 133	TR180S8	TRD180S8	TRDA180S8
3/4" Square	12.5 – 250	9.2 – 185	TR250S12	—	—
3/4" Square	25 – 500	18.5 – 370	TR500S12	TRD500S12	TRDA500S12

*Industry standard transducers require ETA2-TC cable.



Rotary Transducers

Stationary Transducers

Drive Size	Transducer Range		Stationary Transducer	ETA Series “Smart” Transducers
	Nm	ft-lb		
1/4" Square	1.5 – 30	1.1 – 22	TS30S4	TSD28S4
3/8" Square	7.5 – 150	5.5 – 110	TS150S6	TSD135S6
1/2" Square	15 – 300	11 – 221	TS300S8	TSD270S8
3/4" Square	50 – 1000	37 – 738	TS1000S12	TSD1000S12



Stationary Transducer



Joint Simulator

ETA Series Joint Simulators

The joint simulators have a range up to 1000 Nm. Their rate can be changed to emulate different joint conditions from hard to soft. They are useful in tool cribs to preset tools for production and test capabilities under controlled joint rates. The joint kits are available as separate items or as a kit with a stationary transducer.



ETT Torque Tester



ETT Series Expert Torque Testers

- Recommended for most hand screwdrivers, wrenches, or power tools
- Ideal for testing output torque of assembly tools in the calibration lab, repair crib, or on the production line
- Six different languages (English, French, German, Italian, Spanish, and Swedish) standard on all units
- Nine units of measurement for compatibility with global standards
- Charger is equipped with different adaptors for use around the world
- Four operation modes: Peak, Click, Impulse, and Track modes
- High / Pass / Low LED lights
- Auto and manual reset function
- Data transfer function to a PC or printer via the RS232 port
- Diagnostics keep track of past and future calibration dates and current software release
- Eight hours of battery power under normal use
- Auto power down timer keeps unit charged longer
- Quick-clamp mounts integrated into housing
- Quick-disconnect plate available for convenient mounting structure
- Certificate of calibration from National Institute of Standards and Technology included with every unit

Model	Torque Range	
	Nm	in-lb
ETT-1-US	0.1 – 1.0	0.88 – 8.8
ETT-4-US	0.4 – 4.0	3.5 – 35
ETT-12-US	1.2 – 12.0	10.6 – 106
ETT-30-US	3.0 – 30.0	26.5 – 265

Productivity Beyond Product.



Toll-Free 1-866-763-6226 Phone: 905-672-5557
Fax: 905-672-5559 Email: sales@dobcoeqp.com

When you work with Ingersoll-Rand, you get productivity beyond product. Our experts know assembly environments inside and out, and we have the sales, engineering, and service teams in place around the world to deliver a solution tailored to your unique operational needs.

Our 360-degree approach to enhancing your performance includes world-class auditing, products, integration, and service in all areas of the assembly process — fastening, ergonomic handling, lifting, drilling, and dispensing. It's a total solutions approach that will not only meet your needs, but exceed your expectations.



Audits



Ingersoll-Rand consultants can spend time with you, observing and auditing the layout, ergonomic design, and productivity of your assembly process. Our service and sales teams are uniquely qualified to assess your

individual applications and recommend solutions that make sense for you.

You can also take advantage of our best-in-class joint consulting capabilities by sending your parts, components, and fasteners to our Fastening Lab. We'll recommend a fastening strategy that gives you the clamp load you need and the quality and precision your customers demand.

Products



Innovative products are the core of our total solutions approach. From DC electric fastening systems to pulse tools and ESD-safe screwdrivers, our product portfolio spans the full fastening continuum to provide you with the best technology for your application. Add calibration equipment and ergonomic handling solutions to complete your system design. We also offer a comprehensive line of spare parts and accessories including light towers, tool holders, torque arms, cables, sockets, and software.



Integration



Our extensive knowledge of systems integration makes connecting your new equipment to your existing facilities a seamless process. The Ingersoll-Rand service team has years of experience in program management, custom networking, software and PLC programming, and line integration — exactly the combination you need to get up and running.

Service



Want to minimize downtime? No problem. Ingersoll-Rand provides unmatched customer service, and a variety of services to keep you running at your peak — from installation and training to preventive maintenance, calibration, and repairs.

For more information and pricing,
Please Contact:
Dobco Equipment Limited
Ph: 905-672-5557
Fax: 905-672-5559
Email: sales@dobcoeqp.com

